

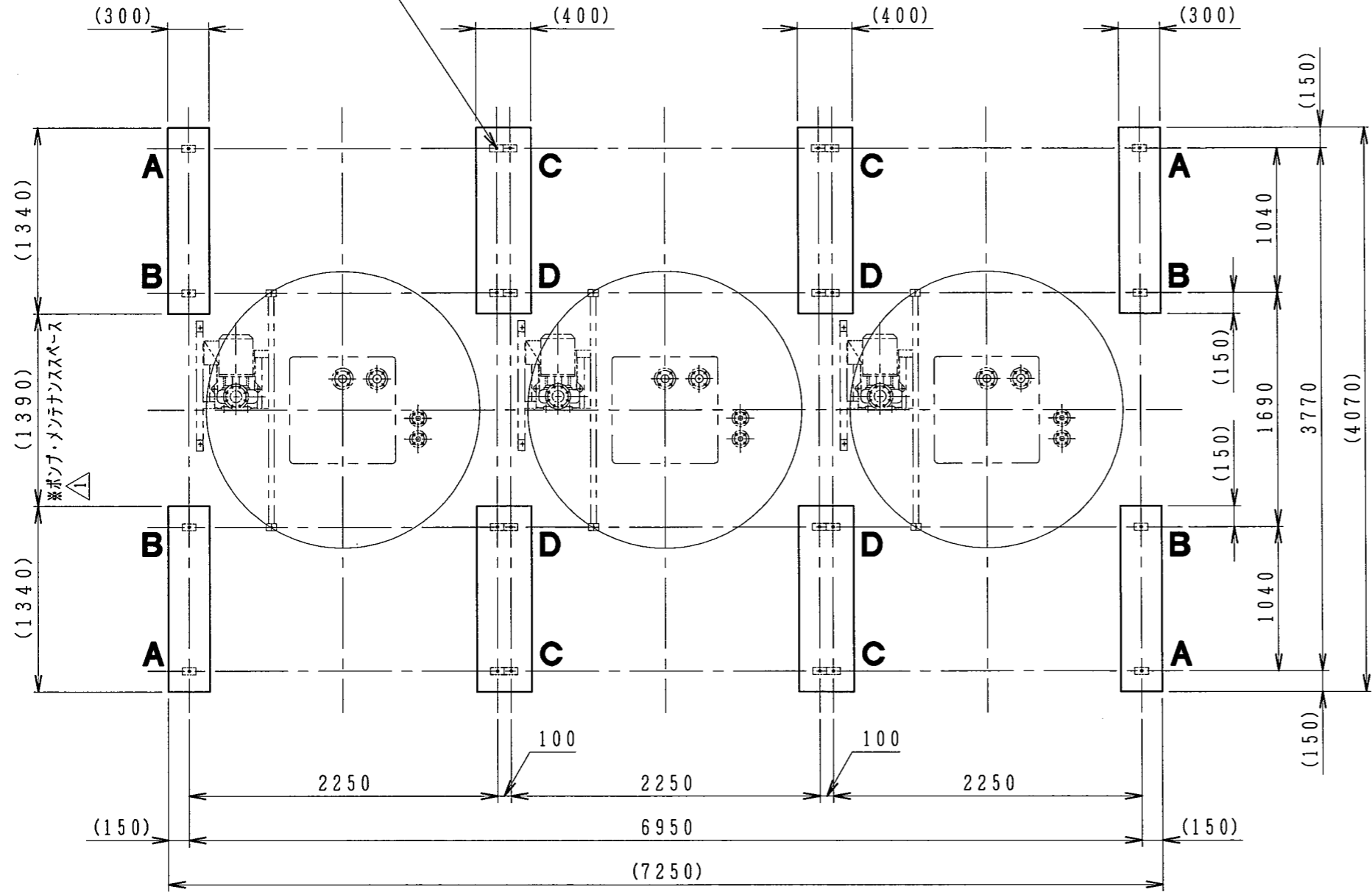

NO. PIECES FOR 1 SET	DESCRIPTION	DWG NO.	MARK	CODE NO.	REMARK
2					
1					

24-M16ケミカルアンカー
 ※アンカーボルトは付属していません。



ローディングデータ
 (長期荷重トン)

A	0.20
B	0.87
C	0.39
D	1.71

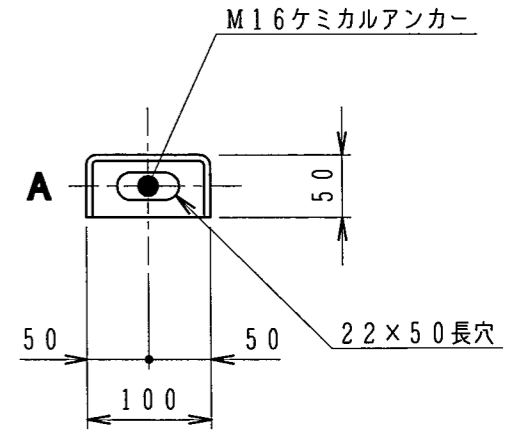
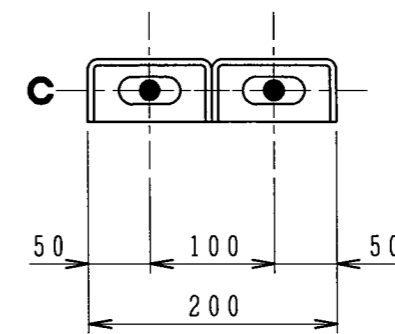
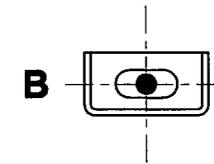
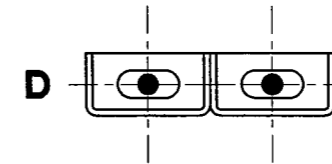

冷却塔脚部形状

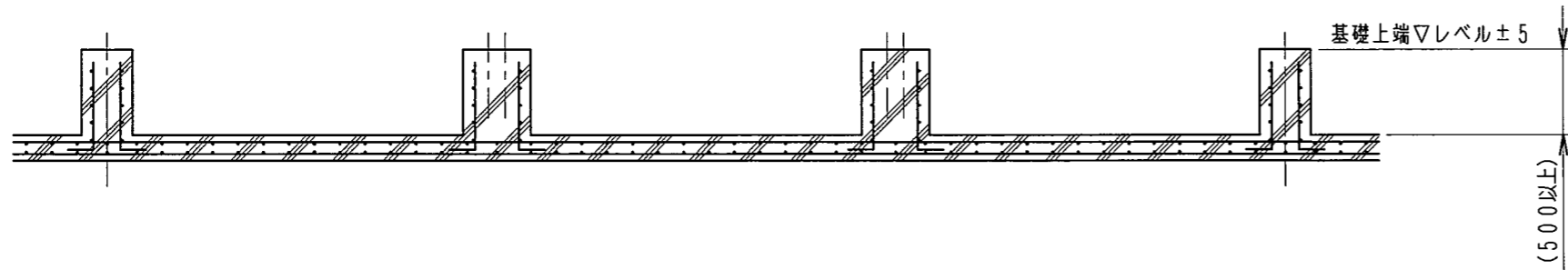

CUSTOMER	WORK NO.	GROUP NO.	NO. OF SETS	REV. NO.	NO.	REVISION	DATE	DRAWN	SCALE	DATE	2004.03.03	CCT-400CUKS
				1	1	基礎形状変更及びポンプ・メンテナンススペース追記	04.09.30	石原	1:40			冷却塔基礎参考図
												DWG NO. 3R-10919

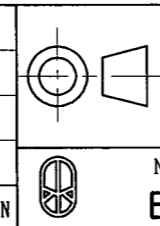

NIHON SPINDLE MFG. CO., LTD. JAPAN
 日本スピンドル製造株式会社